

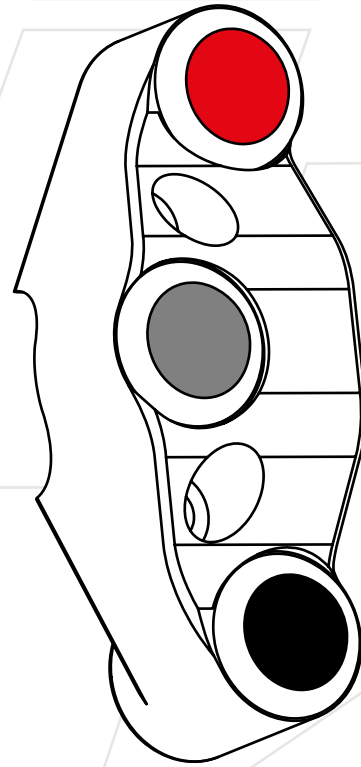

HANDLEBAR SWITCH FOR THROTTLE CONTROL



Ref. JP PLD 157

TECHNICAL FEATURES

- CNC-machined anodized aluminium body
- stronger and lighter than the original part
- IP69K protection
- laser engraving
- wired with RAYCHEM 105° cable and sealed with RAYCHEM S1125 resin

INSTALLATION

This product is plug-and-play, no modification is required on the bike:

1. make sure the ignition is turned off
2. disconnect and remove the original handlebar switch (refer to the manufacturer's workshop manual)
3. remove the fixing bolts and the bracket from the JETPRIME quick throttle control
4. install the JETPRIME handlebar switch on the JETPRIME quick throttle control using the provided bolts, and tighten to 10 Nm
5. connect the wiring to the original connectors

NOTE

This handlebar switch is designed to be mounted on the JETPRIME quick throttle control ACC 127.
It cannot be mounted individually.

FUNCTIONS

1. RUN/STOP
2. START
3. DAYTIME RUNNING LIGHTS

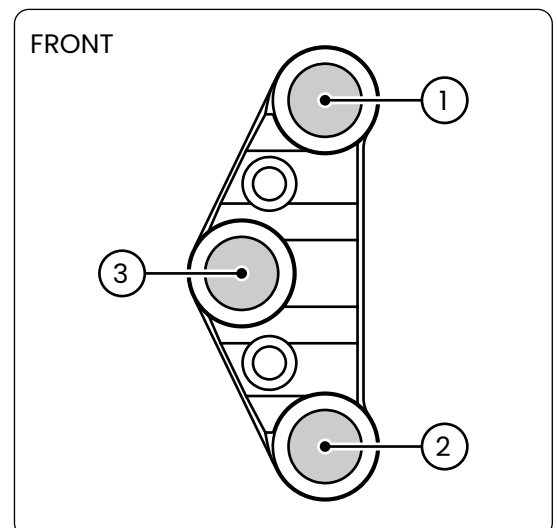



JETPRIME S.R.L.

Via Eugenio Montale, 1
41016 Novi di Modena - Rovereto sulla Secchia (MO)
Phone: +39 059 672223 - Email: info@jetprime.it

www.jetprimeshop.it

All JETPRIME products are designed for racing use only and should be installed by an expert.

The manufacturer, importer, or dealer shall not be liable for any damage caused by improper installation or operation of the JETPRIME product.

The warranty is limited to defects recognized by our technical department and to normal use. The warranty is void in case of accident, modification, improper or racing use.

Do not install the product on a motorcycle for which it was not designed or tested by JETPRIME.

The technical specifications of JETPRIME products and related products are subject to change without notice.